

INNOVATION AND INSPIRATION ON FIRE™



TWIN EAGLES

ENGINEERED  
FOR PRECISION.  
DESIGNED  
FOR STYLE.



## STEP INTO AN AFICIONADO'S OUTDOOR KITCHEN.

Admire the sleek, luxurious, meticulously engineered grill, as beautiful as it is high performance. The man behind our stylish innovation: award-winning engineer and designer, Dante Cantal, natural-born inventor, passionate visionary of the grill and founder of Twin Eagles, with three decades of experience perfecting the finest culinary equipment behind his stellar reputation.

INNOVATION AND INSPIRATION **ON FIRE™**

ARTFUL.  
INNOVATIVE.  
STYLISH.



GRILLING  
PERFORMANCE.  
DESIGN  
PERFECTION.



Get up close and personal. You'll appreciate the unique styling, precisely cut and shaped by our master craftspeople from the finest stainless steel. Interior designers and architects applaud the elegant lines of our premium grills, with their exquisite geometry and polished accents. You'll love the prestigious, innovative designs – the outdoor cooking equipment you deserve, surprisingly attainable.



# GOOD TIMES. GREAT GRILLS.

At Twin Eagles, we listen to our dealers and customers to learn how we can make our products smarter, simpler, more efficient and fun to use. We want you, your family and friends to enjoy grilling, eating and spending time together as much as we do – making memories that linger long after the grill cools down.



# TWIN EAGLES PREMIUM GRILLS.

Here's where it all comes together in our sleek, gorgeous grilling machines. Choose one of our four built-in gas grills, depending on your preferred size and whether you want to include our finely-tuned Concealed Rotisserie System or a Sear Zone. Each grill features our innovatively engineered Five-Part Grilling System, designed for the ultimate grilling synergy.



# TWIN EAGLES PREMIUM GRILLS.

## GRILLING PERFECTED.

Twin Eagles offers you several unique features that together deliver unparalleled performance. Look to the engineering details for the secret sauce in Twin Eagles' grilling perfection – the culmination of decades of experience and innovation by our masters of engineering and design.

 **Internal Halogen Lights** perfectly illuminate nighttime grilling.

 **Extra Large 3-Position Warming & Cooking Rack** allows you to move the rack up and out of the way without removing it from the grill (in stowed position as shown here). Additional rack positions include warming and indirect cooking.

 **Rear Infrared Rotisserie Burner** delivers intense heat and guarantees delicious results for your rotisserie cooked foods.\*

 **Heavy-Duty, Stainless Steel Rotisserie Rod & Forks** supports food weight when cooking for large parties.\*

 **Hexagonal Cooking Grates** retain and conduct heat more efficiently into the food. We design the grates to afford generous surface contact with food, leaving sear marks that would make a professional chef proud. See The Ultimate Grilling System on page 14 for details.

 **Grill Light Switch** automatically turns off the internal halogen lights when the lid is closed, adding longer life to your lights.

 **Control Illumination Switch & Concealed Rotisserie Switch\*** features flush design and illuminated bezels.

\*rotisserie models only



UNPARALLELED  
PERFORMANCE.  
IT'S ALL IN THE  
DETAILS.



**Exclusive Control Illumination** features a highly visible graduated line that glows indigo blue. A control knob indicator notch illuminates to give a precise control knob setting.



**High-polished Accents** reflect the exquisite design and luxurious refinements of your grill and accessories.



**The Grill Hood Assist System** makes it easy for you to open and close the hood by reducing the weight load with hidden heavy-duty extension springs.



**Concealed Heavy-Duty Rotisserie System** features a fully integrated motor with 100 lbs. turning capacity. A unique chain-driven design provides consistent and uniform rotation of the rotisserie rod and two rotisserie rod positions to keep foods the proper distance from the burner, producing exceptional results.

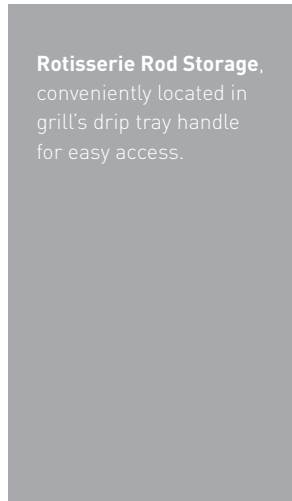

**Rotisserie Rod Storage**, conveniently located in grill's drip tray handle for easy access.



**Hot Surface Ignition** allows you to easily light the gas burners and rear rotisserie burner with our reliable electric hot surface igniters, operated simply by pushing in the burner or rotisserie control knob.

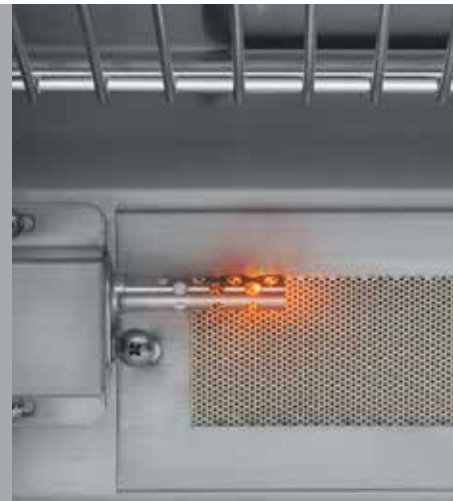

25,000 BTU, 14 Gauge, 304 **Stainless Steel Burners & Zone Dividers**. Each high-performance burner is contained to control heat independently from one grilling area to another.



**The Sealed Smoker Box** holds soaked hickory, mesquite, or your favorite wood chips for all you flavor mavens who crave a subtle smoky taste.



# THE ULTIMATE GRILLING SYSTEM

Our proprietary 5-Part Grilling System utilizes advanced technology and components designed and engineered exclusively by Twin Eagles.

This unique synergistic grilling system integrates direct and radiant heat to ensure your grill:

- Preheats faster
- Reaches higher temperatures
- Distributes heat more evenly
- Offers complete control in each grilling zone
- Uses less gas



1 DRAFTING

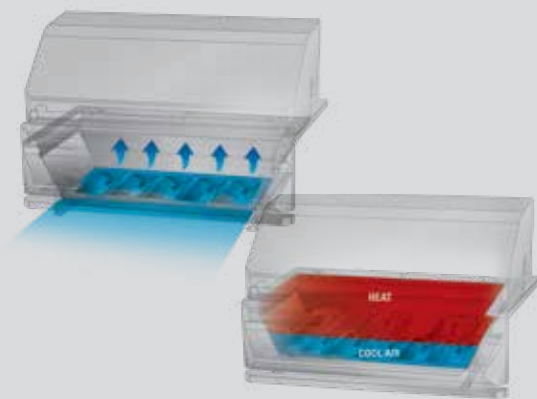

When you ignite the burners, heat rises and creates drafting which draws clean cool air through vents located at the bottom of the firebox.

#### RESULT

- **Keeps the heat above the burners, accelerating its movement to the cooking surface.**
- **Air/gas mixture remains constant for a more efficient flame.**
- **Eliminates stress to the burners from heat, the number one cause of burner fatigue.**

2 DIRECT HEAT

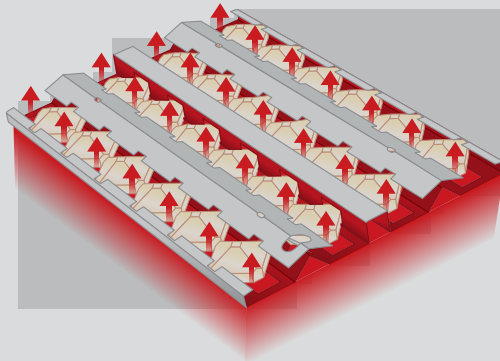

Other grill systems operate solely off the principle that heat rises, which can create hot and/or cold spots. Heat will also follow the path of least resistance. Our exclusive system uses briquette trays with channels that direct heat systematically.

As the heat is pushed upward, it passes through ports located between the ceramic briquettes.

#### RESULT

- **Supplies the intense heat preferred for searing and grilling.**
- **Preheats your grill faster.**
- **Minimizes gas use.**

3 RADIANT HEAT

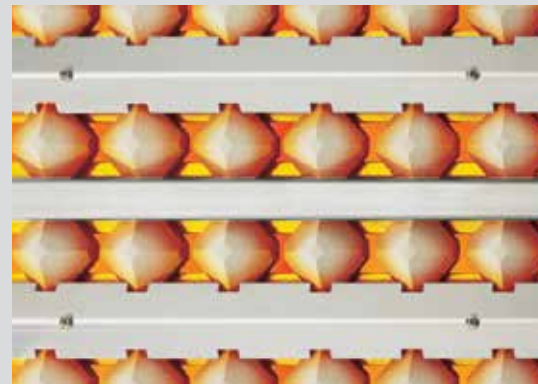

High-grade ceramic briquettes distribute radiant heat evenly to the cooking surface, essential for consistent grilling.

Part of the preheating process involves bringing the ceramic briquettes to temperature. Absorbing heat into the bottom of the briquettes and transferring it out the top takes time and uses gas. Instead of relying solely on absorbing heat into the bottom of the briquettes, the Twin Eagles system also absorbs heat into the sides and tops of the briquettes from channels located between the rows of briquettes.

#### RESULT

- **Briquettes reach temperature in a fraction of the time using less gas.**
- **Even distribution of heat.**

4 ZONE GRILLING



The Twin Eagles grill allows you to cook multiple food items at different temperatures. A divider between each burner breaks the grilling surface into zones. You can operate all zones at the same temperature level or control each zone temperature independently.

Zone grilling also permits you to grill one or two items efficiently with only one burner operating. Since drafting pushes the heat upward, it's concentrated in one zone and will not spread throughout the firebox.

#### RESULT

- **Lets you effectively operate one zone only for small volume grilling.**
- **Allows you to operate all zones at one temperature level or control the temperature of each zone independently to grill a variety of foods at once.**

5 HEXAGONAL GRATES



Grates on most grills serve one purpose: to hold your food. Twin Eagles grates actually aid in the grilling process by absorbing, retaining and conducting heat into your food. The thicker or heavier the grate, the more heat it will absorb and retain.

We use 3/8 inch hexagonal stainless steel rods in our grates. They offer over 20% more mass than most grates and 10% more mass than 3/8 inch round rods. The increased mass retains more heat.

The flat surface of the hexagon rods creates more food-to-surface contact versus round grates, allowing more heat to be conducted into your food.

#### RESULT

- **Food cooks more evenly.**
- **Creates deeper and thicker restaurant-style sear marks.**



# PREMIUM GRILLS

We use premium-grade 300 series stainless steel, precisely cut with advanced lasers and constructed with heli-arc welding technology for the intense strength and durability essential for outdoor use. You'll see and feel our commitment to quality in every interaction with our superbly engineered and crafted equipment – responsive, intuitive, easy to use. And your family and friends will taste it in every delicious bite.

## OUR STANDARD GRILL FEATURES

- 25,000 BTU burners, constructed of 14 gauge 304 stainless steel with lifetime warranty
- High-quality ceramic briquettes
- Hexagonal grates for maximum food-to-surface contact
- Zone dividers to regulate different temperatures
- Reliable hot surface ignition
- Easy-to-open hood assist system
- Interior lights with hood-activated light switch for nighttime grilling
- Exclusive Control Illumination provides a precise control knob setting
- Extra Large 3-Position Warming & Cooking Rack
- Large capacity smoker box



### SEAR ZONE

Sear foods faster with 25,000 BTUs of direct, intense infrared heat to seal in natural juices, for moister, more flavorful foods. You can choose to include a Sear Zone on our 30", 36" and 42" grills. Standard on the 54".



### CONCEALED HEAVY-DUTY ROTISSERIE SYSTEM

Our innovative rotisserie features a fully integrated rotisserie motor with 100 lbs. turning capacity. A unique chain-driven design provides consistent and uniform rotation of the rotisserie rod. Two rotisserie rod positions keep foods the proper distance from the infrared burner, producing exceptional rotisserie cooked foods. You can choose to include a Concealed Rotisserie System on our 30", 36" and 42" grills. Standard on the 54".

## 30" OUTDOOR GAS GRILLS

- TEBQ30G-C** 30" OUTDOOR GAS GRILL (SHOWN)
- TEBQ30R-C** 30" OUTDOOR GAS GRILL WITH INFRARED ROTISSERIE
- TEBQ30RS-C** 30" OUTDOOR GAS GRILL WITH INFRARED ROTISSERIE AND SEAR ZONE



## 36" OUTDOOR GAS GRILLS

- TEBQ36G-C** 36" OUTDOOR GAS GRILL
- TEBQ36R-C** 36" OUTDOOR GAS GRILL WITH INFRARED ROTISSERIE (SHOWN)
- TEBQ36RS-C** 36" OUTDOOR GAS GRILL WITH INFRARED ROTISSERIE AND SEAR ZONE



## 42" OUTDOOR GAS GRILLS

- TEBQ42G-C** 42" OUTDOOR GAS GRILL
- TEBQ42R-C** 42" OUTDOOR GAS GRILL WITH INFRARED ROTISSERIE (SHOWN)
- TEBQ42RS-C** 42" OUTDOOR GAS GRILL WITH INFRARED ROTISSERIE AND SEAR ZONE



### 54" OUTDOOR GAS GRILL

TEBQ54RS-C 54" OUTDOOR GAS GRILL WITH SEAR ZONE AND TWO INDEPENDENTLY-CONTROLLED INFRARED ROTISSERIE BURNERS

#### ALL THE BELLS AND WHISTLES

For backyard barbecue mavens who like to entertain big and juggle several grilled foods at once, your dream machine has arrived.



### 30" OUTDOOR CHARCOAL GRILL

TECG30-C 30" CHARCOAL GRILL WITH ADJUSTABLE CHARCOAL TRAY AND AIR/TEMPERATURE CONTROL LOUVERS

#### IN HONOR OF THE BACKYARD PURIST

For those who crave the basic art of charcoal grilling, Twin Eagles gives you the ultimate way to light your fire. We've invented the future of charcoal grills, with easy air temperature control, an inset temp gauge and front-door fuel access to manage the subtle mechanics of the charcoal art form. A must-have for every outdoor kitchen.

- Seamless welds and signature high-polished accents
- Double-lined hood
- Temperature gauge
- Warming/cooking rack
- Adjustable charcoal tray



AIR/TEMPERATURE CONTROL LOUVERS



EASY CHARCOAL ACCESS FRONT DOOR



# THE ULTIMATE WOOD FIRED PELLET SMOKER & GRILL

- TEPG36G** 36" WOOD FIRED PELLET SMOKER & GRILL
- TEPG36R** 36" WOOD FIRED PELLET SMOKER & GRILL WITH ROTISSERIE (SHOWN)

**THE WOOD FIRED PELLET SMOKER & GRILL** combines the ultimate in performance and convenience, setting the standard for premium pellet grills. Accurate and versatile temperatures from 140° to 725°. Smoke, Bake, Grill, Sear & Rotisserie Cooking features deliver amazing results at the push of a button.

- All 304 stainless steel, seamless heli-arc welded construction and signature hi-polished accents.
- 3-Tiered cooking racks (racks included).
- Internal halogen lights for nighttime cooking.
- Variable speed fan.
- Heavy duty 120V auger motor.
- Removable burner pot for easy cleaning and maintenance.
- SmokePlus™ feature to quickly infuse natural smoke flavor.
- Pellet storage drawer available for built-in applications (Model TESD361-B).



**TOUCHSCREEN CONTROL**  
Large, sleek, weather proof touch screen control allows you to manually set temperatures from 140° to 725° or choose one of several preprogrammed food items with multiple levels of doneness - Select and cook.

**WI-FI ENABLED**  
Monitor and manage temperatures from your mobile device (Apple and Android applications with real-time updates).



## BUILT-IN WOOD FIRED PELLET SMOKER & GRILL



**Extra-Thick Vaporizer Plate**  
Vaporizer plate is extra-thick 16-gauge stainless steel, prevents flare-ups, promotes natural convection and turns drippings into flavorful smoky vapors.



**Maximum Heat Retention**  
Double walled front hood and heavy duty, oven grade, braided 304 stainless steel gasket create the perfect insulation and seal for maximum heat retention.



**Drip Trays**  
Two independent drawers catch ashes and debris in removable / disposable pans for easy clean up. Additional space in the front of each drawer provides extra storage.



**Concealed Heavy-Duty Rotisserie System**  
Fully integrated motor with 100 lbs. turning capacity and unique chain-driven design provides consistent and uniform rotation of the rotisserie rod producing exceptional results.

**Lump Wood or Charcoal / Direct Heat**  
Use lump wood or charcoal to create an ideal direct heat cooking environment. A fan assists in reaching your desired temperature quickly.



**Front Load Hopper**  
Easy access front load pellet hopper with 13 lbs. capacity, allows you to quickly and conveniently check the pellet level and refill when necessary.



**Hanger Hooks**  
Three stainless steel hooks with five positions allow you to hang foods. Suspend sausages and other foods over the grill surface for even cooking and perfect smoke flavor.



**Sear / Direct Heat**  
Our exclusive briquette tray delivers the perfect combination of direct and radiant heat. Ideal for traditional grilling or finishing foods with a quick sear.



**3 Temperature Probes**  
Monitor the temperature of multiple food items simultaneously. Food temperatures can be monitored on the grills control panel or remotely with the Wi-Fi enabled App.

## ROBUST FEATURES. ULTIMATE PERFORMANCE.



**Freestanding Unit Available**  
An integrated grill base (Model TEPGB36) is available for the Pellet Smoker & Grill. Standard features include center pellet storage drawer, soft-closing doors, fold-down side shelves with tool holders, and heavy-duty casters with front brakes for easy maneuverability and locking.

# COOKING ACCESSORIES

## TESB131-C & TESB132-C | SIDE BURNERS

### COOK OUTSIDE THE GRILL.

Add one or two of our versatile 17,500 BTU dual ring sealed burners to your outdoor kitchen as the perfect complement to your grill, so you can simultaneously boil and stir-fry, sauté or simmer. The one-piece stainless steel "S" grate allows for easy maneuverability of pots and pans between burners.

- Available models:
  - Single burner (TESB131-C)
  - Double burner (TESB132-C)
- Built-in wind guard
- Stainless steel cover included
- Exclusive Control Illumination



## TEBC30-C | DINE & BREAKFAST CLUB

### DOUBLE YOUR OUTDOOR FUN.

We invented this griddle and burner duo for those gorgeous days when you want to be outside from morning to evening. Please the crowd with pancakes and omelets at breakfast or quesadillas and sautéed vegetables at dinner. Easy to light and offers precision temperature control. The perfect companion to your grill.

#### GRIDDLE

- Stainless steel, solid cooking griddle surface
- Thermostat control with heat on indicator light
- Electric hot surface ignition with safety gas valve
- 20,000 BTU stainless steel griddle burner
- 120 V electrical power cord supplied

#### SIDE BURNER

- Stainless steel "S" grate to easily slide pots and pans
- Two (2) 17,500 BTU dual-ring European sealed burners
- Electronic ignition
- Stainless steel cover included
- Exclusive Control Illumination



## TETG30-C | TEPPANYAKI

### JAPANESE STYLE. AMERICAN INGENUITY.

We borrowed inspiration from Japanese iron plate cooking to create our unique, easy-to-use Teppanyaki griddle, a versatile addition to your outdoor kitchen. Perfect for cooking breakfast pancakes or omelets, we love using it all day – from grilled cheese sandwiches at lunch to stir-fried vegetables at night.

- Stainless steel, solid 5/16" thick griddle surface
- Two independent thermostatically-controlled gas burners
- Total of 40,000 BTUs
- Heat on indicator lights
- Hot surface ignition with safety gas valve
- 120 V electrical power cord
- Stainless steel cover
- Exclusive Control Illumination



## TEPB24-C | POWER BURNER WITH TRADITIONAL BAR GRATE

## TEPB24HG-C | POWER BURNER WITH REVERSIBLE HEAVY DUTY PLATE GRATE (SHOWN)

### TURN UP THE HEAT

Our incomparable oversized, cast brass, 2-ring Power Burner – rated at 70,000 BTUs – makes all other residential burners jealous with heat envy. We construct the reversible commercial cooking grate on Model TEPB24HG-C from 8 mm stainless steel welded plates. This accessory should star in every outdoor kitchen.

- Powerful 70,000 BTU burner with low simmer
- Reversible grate for restaurant stockpots and commercial woks (model TEPB24HG-C)
- All stainless steel commercial design cooking grate made of welded plates (model TEPB24HG-C)
- Reliable hot surface ignition
- Stainless steel cover included
- Exclusive Control Illumination
- Griddle plate accessory available - overall dimensions 18" x 18" (Model TEGP18-PB)



TESG24 | SALAMANGRILL

FAST UNDER FIRE

Sear your steaks to juicy perfection or fire up a family-pleasing pizza in minutes with our high-performance patented Salamangrill. The infrared burner mounted above the cooking surface reaches 1700 degrees in 90 seconds to intensify juiciness and flavor without flare-ups. We throw in a 13" pizza stone for extra fun.



- Four-level position carriage cooks:
  - Pizza in 4 minutes
  - 1 ½" steaks in 6 minutes
  - Fish in 6 minutes
  - Chicken in 6-8 minutes
- 15,000 BTU infrared burner
- Cooking grate rolls in and out for easy food placement
- 13" pizza stone included
- Patented technology (U.S. Patent #7,117,866 B2)
- Custom vinyl cover included



TEWD30-C | 30" WARMING DRAWER

WARMING IN THE WINGS

Savvy outdoor cooks appreciate being able to prepare ahead, especially when coordinating a large meal. Keep food warm and ready to serve with our convenient warming drawer. Humidity management controls moderate moisture inside the drawer to prevent food from drying out. Low to high heat settings offer versatile uses from warming towels to defrosting food.



- Four (4) steam pans specifically designed for steam or dry warming
- Concealed thermostat control
- Heat ranges from 60° to 220° F (15° to 104° C)
- 120 V electrical cord included
- Approved for indoor and outdoor use



TEWD42C-C | 42" WARMING DRAWER COMBO

A TOP DRAWER COMBINATION

Keep food warm, moist and ready to serve – and take advantage of extra storage with this smart, convenient multi-purpose unit. A storage drawer below the warmer lets you keep towels and mitts on hand. Use the large slide-out holder for a trash container or LP gas tank.



- 2.1 cu. ft. storage drawer
- Four (4) steam pans specifically designed for steam or dry warming
- Humidity controls keep food from drying out
- Heat fluctuation from 60° to 220° F (15° to 104° C)
- Concealed thermostat control
- 120 V electrical cord included
- Approved for indoor and outdoor use

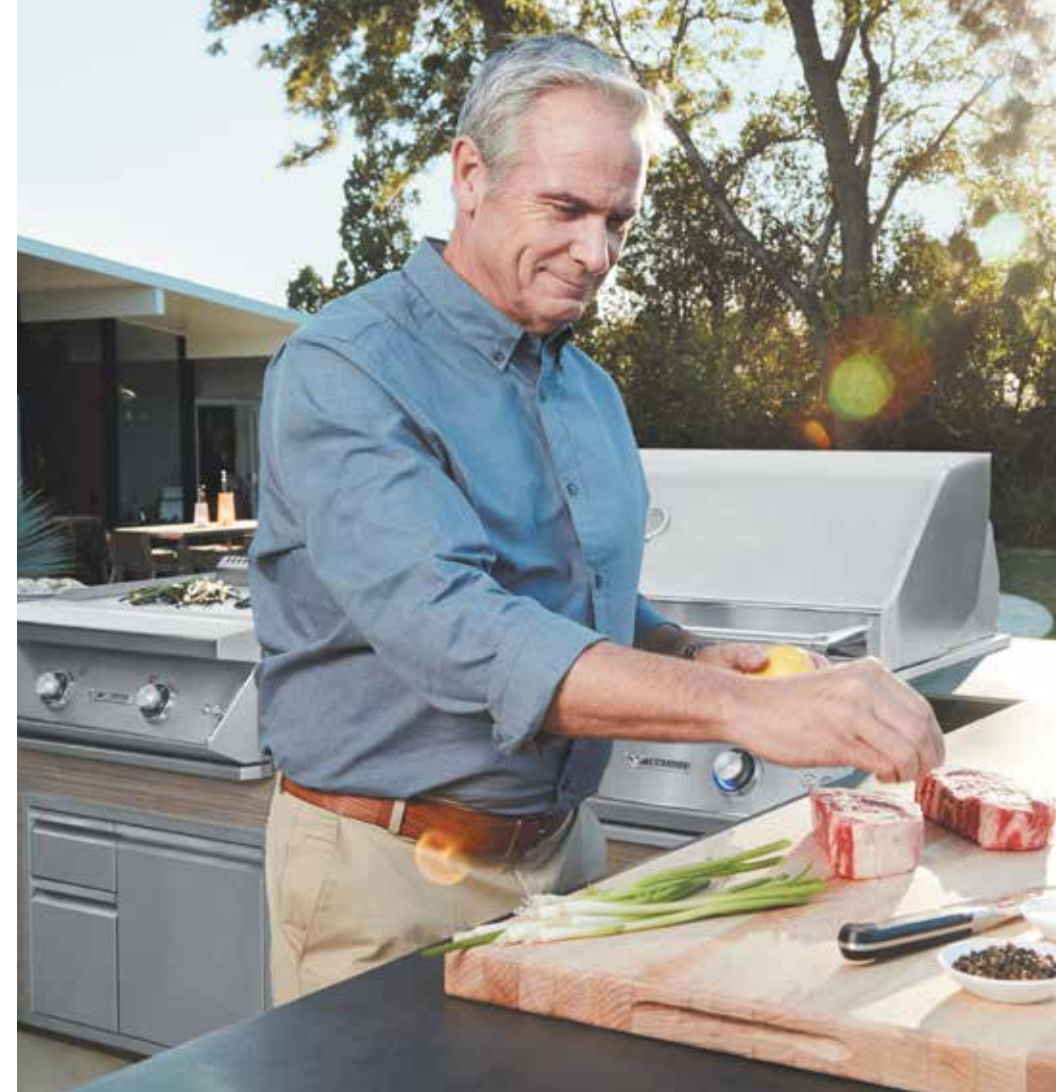

# BAR ACCESSORIES

## TEOB30-B | 30" OUTDOOR BAR

### ICE-COLD & CONVENIENT

Complete your backyard sanctuary with our convenient outdoor bar and you'll never have to run inside for ice again. Our 30" bar includes an insulated ice compartment that holds up to 40 pounds of ice. Keep beverages cool and condiments fresh in three specially-designed cooling compartments.



- Stainless steel sliding ice bin cover
- Front speed rail holds 1-liter bottles
- Stainless steel bottle opener and towel ring
- Stainless steel bar sink and chrome faucet



**FRONT SPEED RAIL**  
Holds 1-liter bottles

## TEOB18-B | 18" OUTDOOR BAR

### THE PERFECT MINI-BAR

This compact beverage center features an insulated ice compartment that holds up to 40 pounds of ice and three cooling compartments to keep beverages on ice and condiments fresh. Excellent for outdoor entertaining.



- Stainless steel sliding ice bin cover
- Front speed rail holds 1-liter bottles
- Stainless steel bottle opener and towel ring



**STAINLESS STEEL BOTTLE OPENER**

## TEMC18 | 18" MARGARITA CENTER

### PLUG AND PLAY

Mix it up to perfection and impress your guests with this versatile appliance station, complete with built-in GFCI (120 V) electrical outlet. Create a cocktail mixing center, coffee & espresso bar or fresh juice bar with your preferred appliance, for endless entertainment possibilities from morning to midnight. (Blender not included.)



**BUILT-IN ELECTRICAL OUTLET**  
GFCI (120 V)

## TEOS24-B | 24" DROP-IN SINK

### EVERYTHING INCLUDING THE KITCHEN SINK

Our elegant, commercial-quality sink boasts an oversized basin to accommodate large items and a soap dispenser for quick cleanup. Beautifully designed with seamless welded construction for long life and to complement your other outdoor equipment. An outdoor kitchen essential.



- Integrated soap dispenser
- 3.5-inch stainless steel basket drain
- Cold or Hot/Cold faucet sold separately
- Includes stainless steel cover



**INTEGRATED SOAP DISPENSER**

**TEOR24-F | 24" OUTDOOR REFRIGERATOR**

**CHILL WHILE YOU GRILL**

The ultimate backyard kitchen convenience, this stylish, outdoor refrigerator features 5.1 cubic feet of storage, two perforated slide-out shelves and door storage. Keeps marinated meats, side dishes and beverages barbecue-ready. A must-have.



- Approved for outdoor use
- Stainless steel exterior sides, top and full wrap door
- Interior LED lighting
- Door lock for added security
- Precise temperature management between 34° and 42° F



**TERD242-F | 24" TWO DRAWER OUTDOOR REFRIGERATOR**

**COOL HIDEAWAY**

Enjoy the convenience of refrigerated drawer storage that provides easy access to food and beverages.



- Approved for outdoor use
- Durable stainless steel drawer construction
- Interior LED lighting
- Drawer lock for added security
- Precise temperature management between 34° and 42° F
- Energy efficient thermal insulated cabinet



**TEBK24-F | 24" BEER DISPENSER/SINGLE TAP**  
**TEBK242-F | 24" BEER DISPENSER/TWIN TAPS**

**THE LIFE OF THE PARTY**

Serve your favorite draft microbrew frosty cold and straight from the tap. Our beer dispenser holds half or quarter kegs and includes the draft tower, CO2 tank and regulator. Party central.



- Approved for outdoor use
- Two stow-on-board shelves that can be used when a keg is not installed
- Door lock for added security



**TEIM15-F | 15" OUTDOOR ICE MACHINE**

**BREAK THE ICE**

This sleek, efficient beauty produces up to 35 pounds of ice per day and stores up to 15 pounds of ice. An asset to any outdoor bar primed for epic backyard entertaining.



- Approved for outdoor use
- Stainless steel door
- Stainless steel louvers with front in/ front out air flow
- 35 lbs. daily ice production
- 15 lbs. of built-in storage capacity
- Optional drain pump available (model TEDP-KIT-F)



**TEOC24D-B | 24" DROP-IN COOLER**

**DRINK AND BE MERRY**

This premium, party-ready drop-in cooler accommodates up to 60 bottles and 25 pounds of ice. The insulated bin and gasket-sealed lid keep contents ice-cold into the wee hours. Sleek, geometrical design shows off our signature polished accents and seamless welds.



- Removable/sliding condiment tray
- Removable lid with heavy duty hinges
- Brass drain with plug





# DRAWERS

## CLEVER CONCEALMENT

We design our built-in access doors and storage drawers with the same attention to detail as our premium grills and accessories. The external design complements our equipment, with Twin Eagles' signature exquisite polished accents, sleek finish and geometrical detailing. We engineer each door or drawer to slide seamlessly and effortlessly into place, with a weight-bearing strength and long-lasting durability intensified by the highest quality stainless steel.

### TETD182T-B | 18" DOUBLE TRASH DRAWER



- Holds two larger capacity trash containers (containers included)
- Use one container for waste, a second for recycling
- Flush handle design with high-polished accent
- Full pullout drawer for easy access (100 lbs. capacity)

### TETD18T-B | 18" TRASH DRAWER



- Holds larger capacity trash container (container included)
- Flush handle design with high-polished accent
- Full pullout drawer for easy access (100 lbs. capacity)

### TETC-B | TRASH CHUTE

Smart, low profile trash chute aligns over built-in trash drawers (TETD18T-B or TETD182T-B) for easy disposal of bottles, trash and waste. A commercial cutting board also serves as a practical sliding lid. A stainless steel cover fits over the cutting board and chute to conceal when not in use.



- Removable sliding cutting board
- Angled side wall directs waste to trash container below
- Stainless steel cover included
- Aligns over the built-in trash drawers (sold separately)

### TEPT15SD-C | 15" PAPER TOWEL DRAWER



- Holds standard-size paper towels
- Slide-out paper towel drawer
- Towel bar
- Storage tray

### TECD30-B | 30" COOLER DRAWER

Keep a cooler on hand and out of the way of the action, with our convenient cooler drawer. Offers easy access to ice, cold beverages or marinated foods in your outdoor kitchen.



- 48 quart ice chest included (color may vary)
- One-piece mounting frame for precision alignment
- Flush handle design with high-polished accents



# ACCESS DOORS

- TEAD18(L/R)-C 18" WIDE ACCESS DOOR (LEFT OR RIGHT HINGED)
- TEAD24(L/R)-C 24" WIDE ACCESS DOOR (LEFT OR RIGHT HINGED)
- TEAD30-C 30" WIDE DOUBLE ACCESS DOORS
- TEAD36-C 36" WIDE DOUBLE ACCESS DOORS
- TEAD42-C 42" WIDE DOUBLE ACCESS DOORS

**ACCESS DOOR FEATURES:**

- Soft-closing, three-way adjustable concealed door hinges
- Double-walled doors
- One-piece mounting frame for precision alignment
- Flush handle design with high-polished accents



# STORAGE DRAWERS

- TESD132-B 13" WIDE DOUBLE STORAGE DRAWERS
- TESD133-B 13" WIDE TRIPLE STORAGE DRAWERS
- TESD192-B 19" WIDE DOUBLE STORAGE DRAWERS
- TESD193-B 19" WIDE TRIPLE STORAGE DRAWERS

**STORAGE DRAWER FEATURES:**

- Self latching, and 100 lbs. capacity, full extension slides
- Extra deep drawers for oversized utensils
- Superior welding and finish
- One-piece front frame for precision alignment
- Flush handle design with high-polished accents



TESD241-B 24" UTENSIL STORAGE DRAWER



TESD24GP-B 24" GRIDDLE PLATE STORAGE DRAWER



TESD301-B 30" LARGE CAPACITY DRAWER



TESD361-B 36" PELLET STORAGE DRAWER



# DOOR/DRAWER COMBINATIONS

## DOOR/TWO DRAWER COMBOS

- TEDD302-B** 30" WIDE DOOR & TWO (2) DRAWER COMBO
- TEDD362-B** 36" WIDE DOOR & TWO (2) DRAWER COMBO
- TEDD422-B** 42" WIDE DOOR & TWO (2) DRAWER COMBO



## DOOR/THREE DRAWER COMBOS

- TEDD303-B** 30" WIDE DOOR & THREE (3) DRAWER COMBO
- TEDD363-B** 36" WIDE DOOR & THREE (3) DRAWER COMBO
- TEDD423-B** 42" WIDE DOOR & THREE (3) DRAWER COMBO



## TETS-KIT | LP TANK/TRASH SLIDE KIT

This convenient and versatile sliding panel accommodates an LP tank or trash container.

- Easily mounts inside any door/drawer combo
- Constructed of heavy gauge stainless steel
- Easy access to LP tank or trash container



# DRY STORAGE CABINETS

## SAFE AND SOUND

Every outdoor kitchen needs a weather-safe place to organize and store essentials. These smartly-designed dry storage cabinets seal snugly to ensure that contents are protected from exposure to the elements. The extra deep interior with fixed shelves and full extension drawers provides generous space and storage flexibility.

## TEDS36-B | 36" DRY STORAGE CABINET

- Perfect companion to the 36", 42" or 54" built-in grill
- 3 full extension drawers behind left-hand door
- Large open storage compartment behind right-hand door
- Overall dimensions: 36" W x 20.75" H



## TEDS36T-B | 36" DRY STORAGE CABINET - TALL

- 34-inch tall cabinet sits just below counter height
- 4 full extension drawers behind left-hand door
- 1 fixed shelf and 2 full extension drawers behind right-hand door
- Overall dimensions: 36" W x 34" H



# VENTILATION

## TEVH36-B | TEVH48-B | TEVH60-B | TWIN EAGLES VENTILATION HOOD

### A BREATH OF FRESH AIR

Safely remove excess smoke, odors and grease to protect your outdoor kitchen area and guests. High performance ventilation hoods draw heat, steam and grease away from your cooking area. Seamless, sophisticated design, with our signature polished geometrical accents, complements our grills and accessories. Available in 36", 48" and 60" sizes.



- Engineered and UL-approved for outdoor use
- Easy to remove, dishwasher safe stainless steel baffle filters
- 3-speed ventilator control
- 2 halogen lamps with dual settings
- Internal and external blower motors sold separately:

**TEVI-060I** 600 CFM INTERNAL BLOWER

**TEVI-120I** 1,200 CFM INTERNAL BLOWER

**TEVE-150E** 1,500 CFM EXTERNAL BLOWER

# ACCESSORIES

## TECT | CHARCOAL TRAY

### THE BEST OF BOTH GRILLS

For those who savor the taste of food cooked over a charcoal flame, you can now enjoy the convenience of lighting it from your grill. We make our charcoal tray of 100% stainless steel and include a built-in ash collector for easy cleaning. Use the existing burner to light the briquettes or lump charcoal.

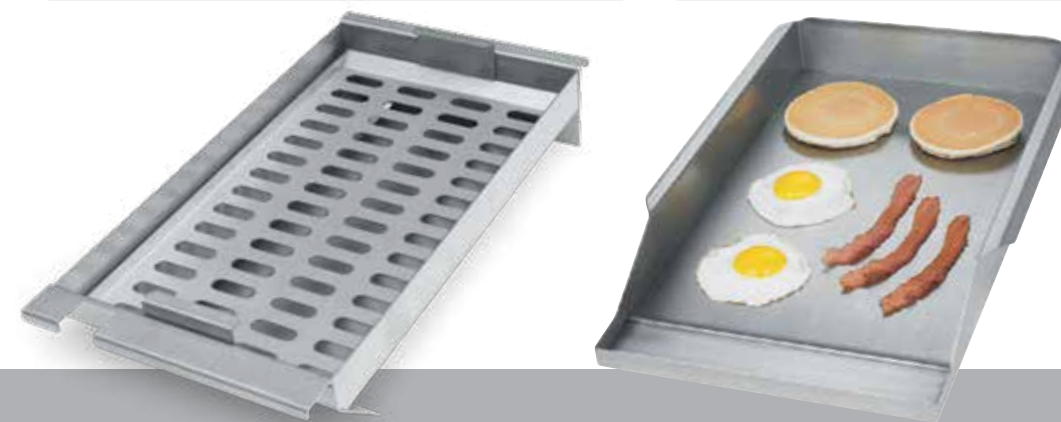

## TEGP12 | GRIDDLE PLATE

### VERSAGRILLITY

Transform our grills or side burners in seconds into a sleek griddle surface. Perfect for grilling pancakes, fajitas, or stir-fry. Made of durable stainless steel.

## VINYL COVERS

### THE PERFECT COVER-UP

Protect your investment with an all-weather vinyl cover. The soft interior protects our fine stainless steel finish, while the durable vinyl exterior shields your grill from harsh weather. Available for all built-in grills and built-in accessories including: Power Burner, Single & Double Side Burner, Dine & Breakfast Club and Teppanyaki Griddle. We also offer covers for all freestanding grills and the freestanding Dine & Breakfast Club and Teppanyaki Griddle.



# FREESTANDING GRILLS

## A MOVEABLE FEAST

Twin Eagles designed these elegant integrated grill bases to offer portability and a freestanding grill option for our 30", 36", 42" and 54" grills. Each grill base features our beautiful signature style and sleek architectural lines to complement our grills and accessories. Standard features include soft-closing doors and self-latching drawers, fold-down side shelves with tool holders, and heavy-duty casters with front brakes for easy maneuverability and locking. Use the convenient pullout tray inside to hold a trash receptacle or LP tank. Access doors and storage drawers feature flush handle design with high-polished accents.



## TOOL HOLDERS

Innovatively designed tool holders on each side shelf keep your tools handy, yet conveniently out of the way, leaving shelves clear for food and other items essential to grilling.



PRODUCT NUMBER	COMPATIBLE PRODUCTS
----------------	---------------------

**TEGB30-B** Compatible with any 30" built-in grill, the Dine & Breakfast Club and Teppanyaki griddle



**TEGB30SD-B** Compatible with any 30" built-in grill, the Dine & Breakfast Club and Teppanyaki griddle



**TEGB36-B** Compatible with any 36" built-in grill



**TEGB36SD-B** Compatible with any 36" built-in grill



PRODUCT NUMBER	COMPATIBLE PRODUCTS
----------------	---------------------

**TEGB42SD-B** Compatible with any 42" built-in grill



**TEGB54SD-B** Compatible with any 54" built-in grill



**TSGB24** Compatible with Salamangrill only



**TESB132F-C** Available for all 30", 36", 42" and 54" grill bases



# HEATERS

## TEGH48-B | 48" OUTDOOR GAS INFRARED HEATER U.S. PATENT# 8,540,509 B1

### TURN UP THE HEAT

Extend your outdoor entertaining into the cool of late evening – or even year round – with our patented radiant gas heater powered by infrared technology. The wireless remote control allows you to adjust heat settings with ease. Enjoy exceptional heat coverage over a wide area to keep you and your guests warm and cozy as long as the party lasts.



- Two heat levels: low setting at 25,000 BTU and high at 37,000 BTU
- Wireless remote control (No electrical wiring required)
- Spark ignition with 100% safety pilot
- Decorative safety grill provides shielding from wind (Windproof up to 15 MPH)
- Includes mounting brackets and gas hose

### TEGH-AC | 120 VAC/6 VDC ADAPTER



- Optional accessory (sold separately)

### HEATING AREA COVERAGE

Heater must be mounted a minimum of 8 feet from floor

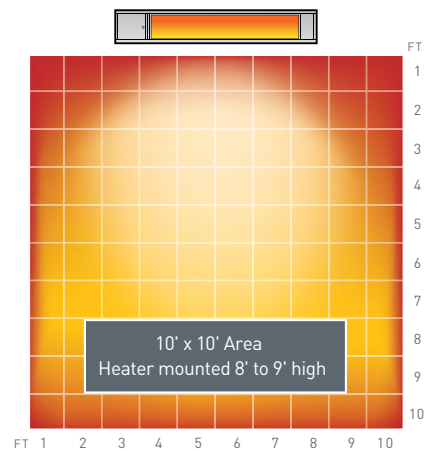

## TEEH2524 | 39" ELECTRIC RADIANT HEATER (INDOOR/OUTDOOR)

LENGTH: 39" • VOLTS: 240 • WATTS: 2500 • AMPS: 10.4

## TEEH3524 | 61" ELECTRIC RADIANT HEATER (INDOOR/OUTDOOR)

LENGTH: 61" • VOLTS: 240 • WATTS: 3500 • AMPS: 14.6

### WARM & COZY

Our energy efficient Electric Radiant Heaters will maintain a warm, comfortable atmosphere on cool nights indoors or outdoors. Designed for installation at lower mounting heights (six to eight feet), these heaters maximize heat where you need it most, making them excellent for coastal areas. We make the parabolic reflector of a special corrosive resistant alloy, an essential feature for humid climates or windy areas. Perfect for entertaining in your backyard, patio or deck.



- Energy efficient: 90% of input energy is converted directly to radiant heat
- Swivel mounting brackets allow 6" of clearance behind heater
- UL approved

### INCREMENTAL CONTROL

Wall-mountable incremental control included for easily regulated heat settings



### HEATING AREA COVERAGE

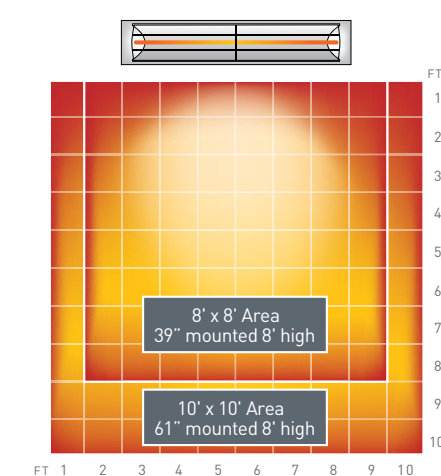

# CUTOUT DIMENSIONS

## COUNTERTOP NOTCH REQUIREMENT

\*Add 3.25" to allow for hood opening

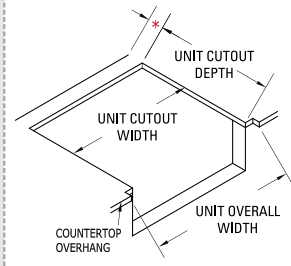

Allow minimum of 2.50" clearance from the grill's rear edge and 3.25" from cutout to the backsplash to allow hood to fully open.

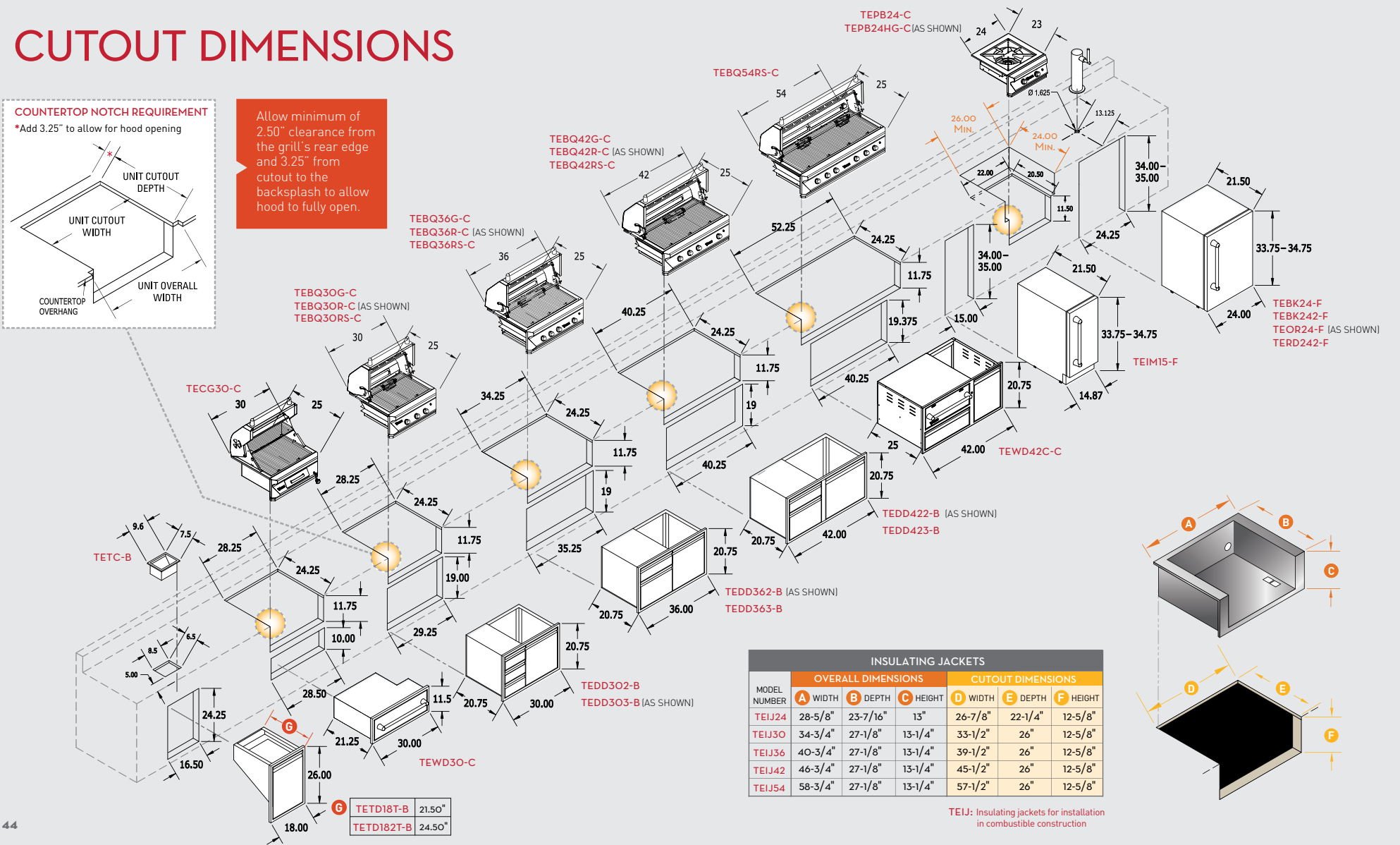

MODEL NUMBER	OVERALL DIMENSIONS			CUTOUT DIMENSIONS		
	A WIDTH	B DEPTH	C HEIGHT	D WIDTH	E DEPTH	F HEIGHT
TEIJ24	28-5/8"	23-7/16"	13"	26-7/8"	22-1/4"	12-5/8"
TEIJ30	34-3/4"	27-1/8"	13-1/4"	33-1/2"	26"	12-5/8"
TEIJ36	40-3/4"	27-1/8"	13-1/4"	39-1/2"	26"	12-5/8"
TEIJ42	46-3/4"	27-1/8"	13-1/4"	45-1/2"	26"	12-5/8"
TEIJ54	58-3/4"	27-1/8"	13-1/4"	57-1/2"	26"	12-5/8"

TEIJ: Insulating jackets for installation in combustible construction

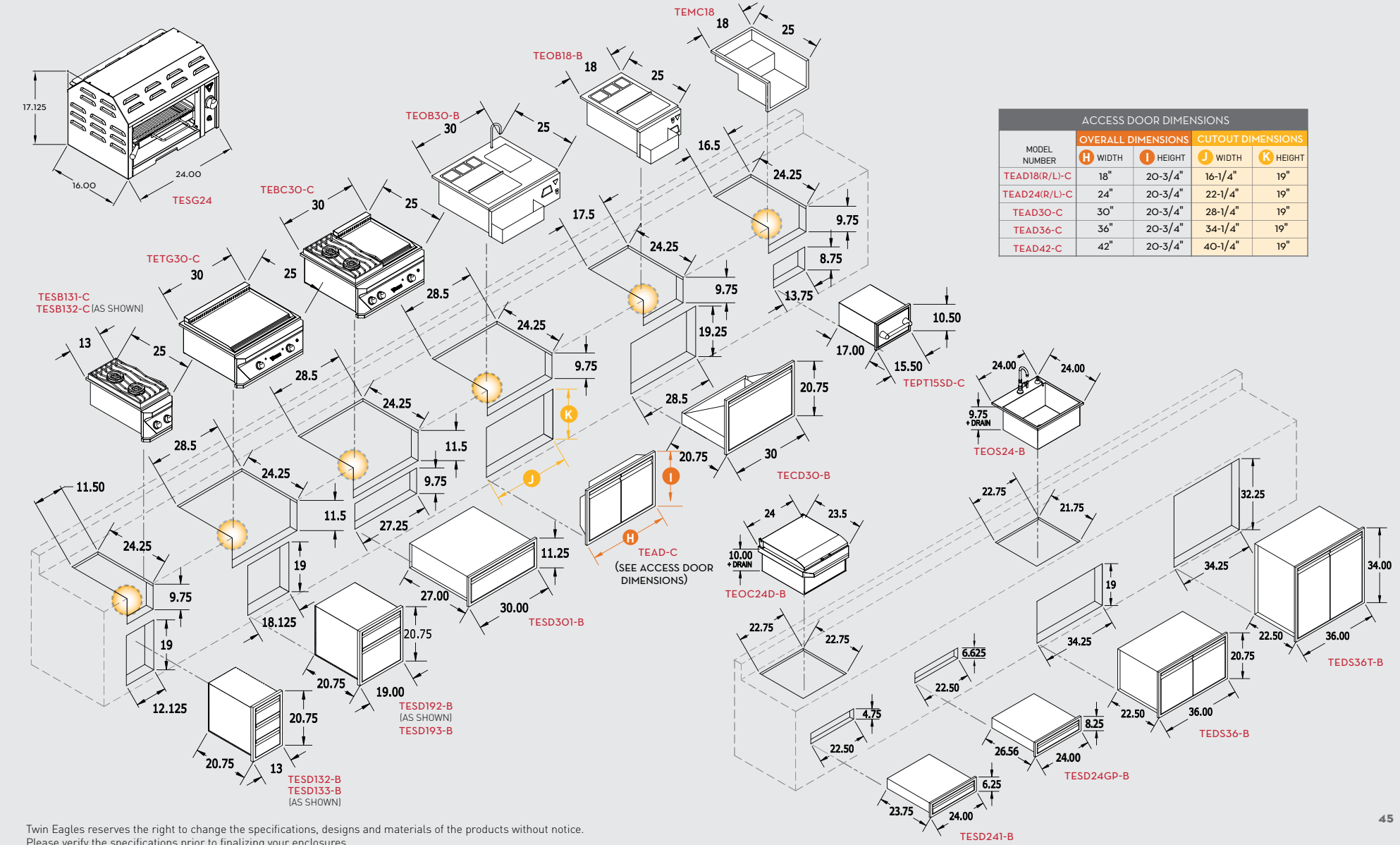
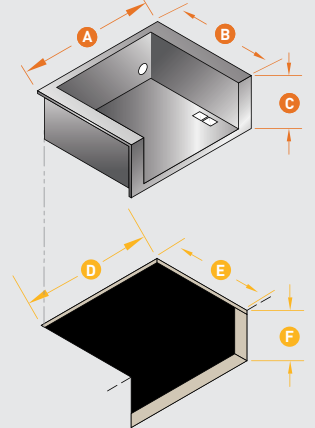

MODEL NUMBER	OVERALL DIMENSIONS		CUTOUT DIMENSIONS	
	H WIDTH	I HEIGHT	J WIDTH	K HEIGHT
TEAD18(R/L)-C	18"	20-3/4"	16-1/4"	19"
TEAD24(R/L)-C	24"	20-3/4"	22-1/4"	19"
TEAD30-C	30"	20-3/4"	28-1/4"	19"
TEAD36-C	36"	20-3/4"	34-1/4"	19"
TEAD42-C	42"	20-3/4"	40-1/4"	19"

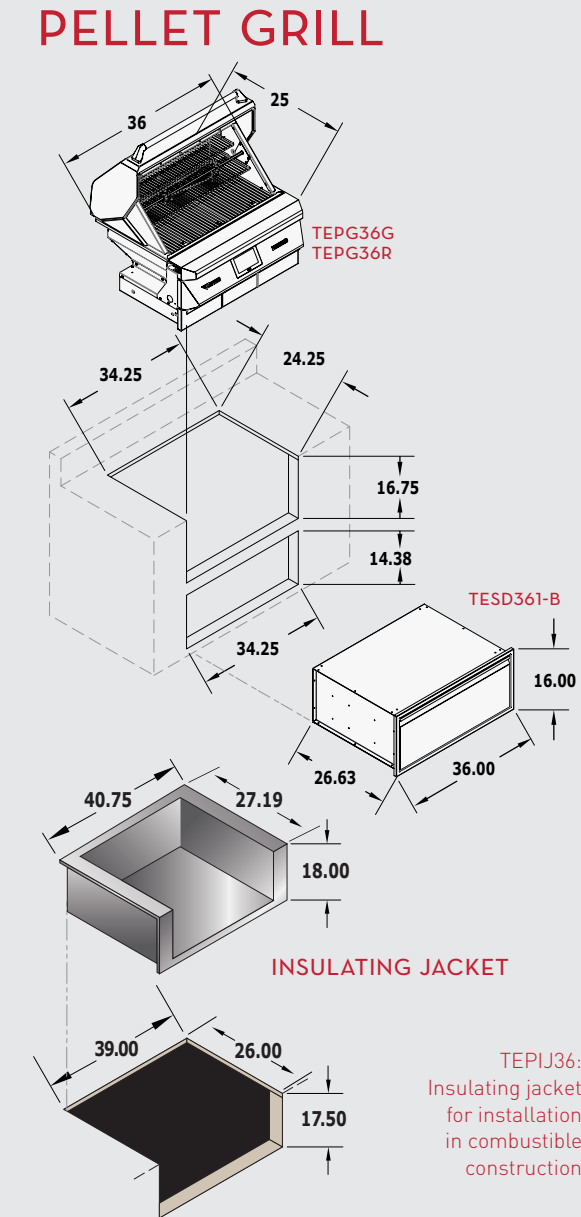

TEPIJ36: Insulating jacket for installation in combustible construction

Twin Eagles reserves the right to change the specifications, designs and materials of the products without notice. Please verify the specifications prior to finalizing your enclosures.

# RESOURCES

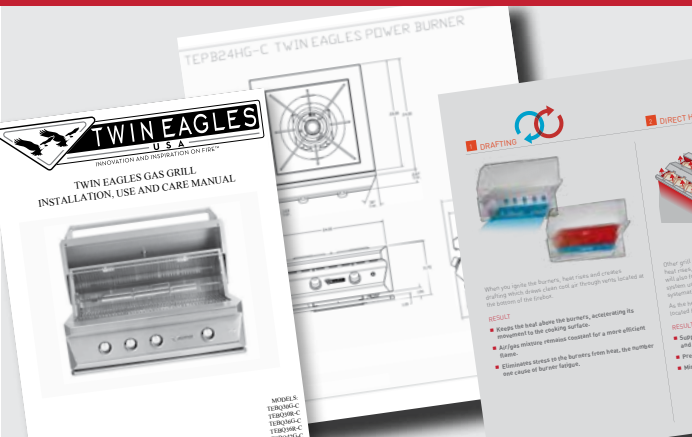

Visit us online for a variety of resources -

[TwinEaglesGrills.com](http://TwinEaglesGrills.com)

- ▶ Care, Use & Installation Manuals
- ▶ Product Images
- ▶ CAD Drawings
- ▶ Product Warranty



# MADE IN THE USA WITH PRIDE

Our name was inspired by the eagle and our founder's twin children. The eagle is the national bird of the United States and represents independence, vision and strength. Twin Eagles shares those same qualities and embraces the very highest standards in our design and manufacturing. All of our products are made in the USA - designed and manufactured to embody the impressive characteristics of the eagle - by the finest craftspeople in the industry at our own state-of-the-art workplace in California.





# RESOURCES



Visit us online  
for a variety of resources -  
**TwinEaglesGrills.com**

- ▶ Care, Use & Installation Manuals
- ▶ Product Images
- ▶ CAD Drawings
- ▶ Product Warranty



TWIN EAGLES, INC®  
13259 EAST 166TH STREET, CERRITOS, CA 90703 | 800 789 2206  
PN 19196B

**WWW.TWINEAGLESGRILLS.COM**  
©2018 TWIN EAGLES, INC. ALL RIGHTS RESERVED.

# PELLET GRILL

