

TrueFlame 48" Vent Hood

SKU: TF-VH-48

NOTES

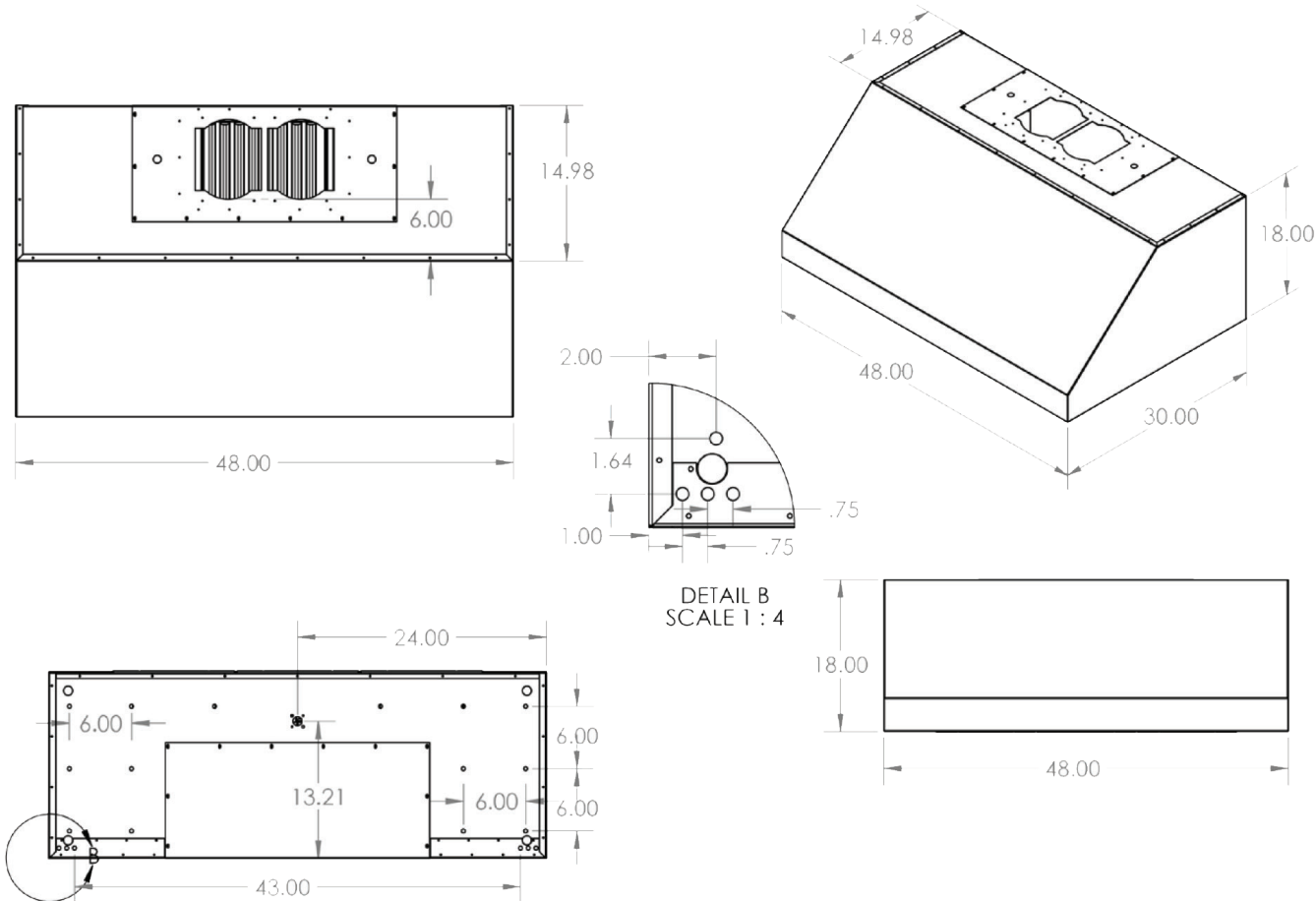

DISCLAIMER

We recommend adding a 1/4" (.25) to the inner dimension to ensure the unit fits properly in the build out.