

FIREMAGIC®

ROTISSERIE KIT

INSTALLER: Leave these instructions with consumer.
CONSUMER: Retain for future reference.

HEAVY-DUTY ROTISSERIE KIT MODELS

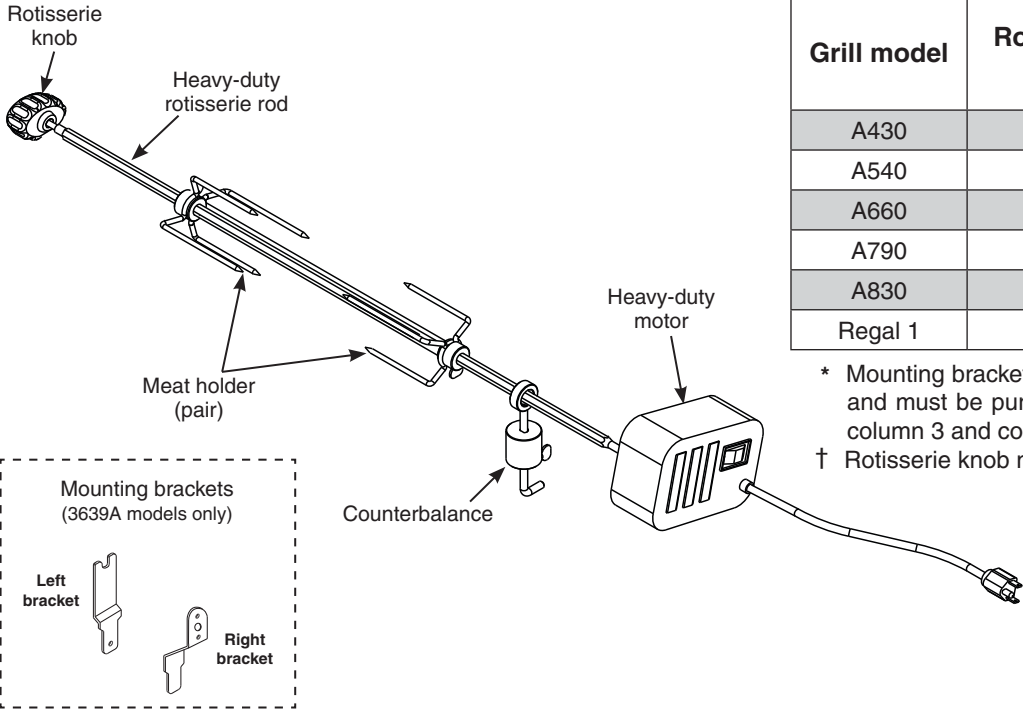

Grill model	Rotisserie Kit model #	Bracket Kit model # (sold separately)
A430	3603A *	3600-63
A540	3626A *	3600-63
A660	3626A *	3600-62
A790	3627A *	3600-62
A830	3614A *†	3600-63
Regal 1	3639A	N/A (included)

* Mounting brackets for these models are not included and must be purchased separately (if needed). See column 3 and contact your local dealer.

† Rotisserie knob not included with this model

SUPER HEAVY-DUTY ROTISSERIE KIT MODELS

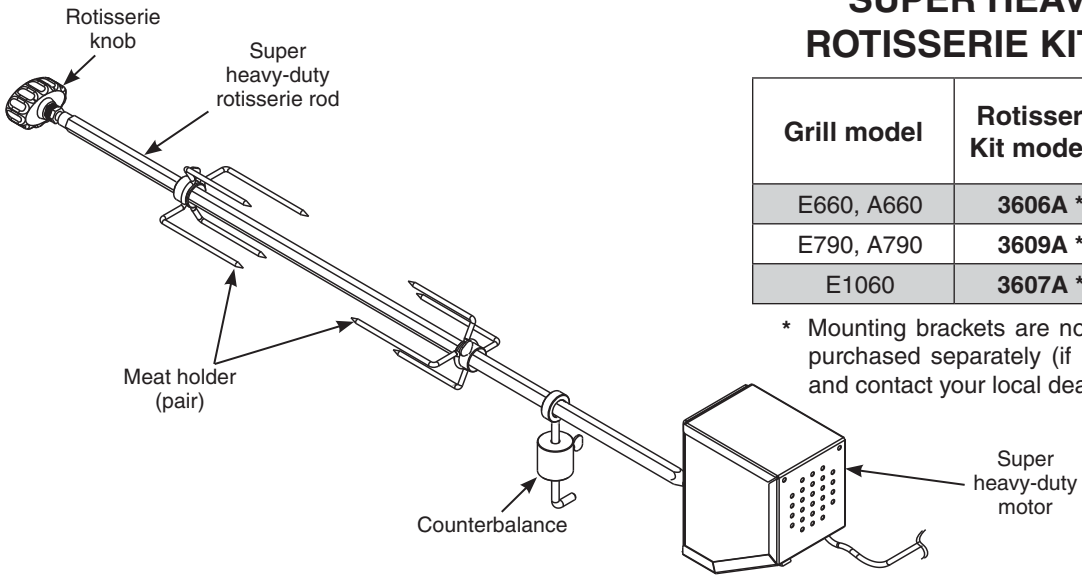

Grill model	Rotisserie Kit model #	Bracket Kit model # (sold separately)
E660, A660	3606A *	3600-61
E790, A790	3609A *	3600-61
E1060	3607A *	3600-60

* Mounting brackets are not included and must be purchased separately (if needed). See column 3 and contact your local dealer.

MOUNTING BRACKET INSTALLATION (3639A MODELS ONLY)

If you purchased a bracket kit separate from this rotisserie kit, use the instructions provided with the bracket kit to install the brackets.

To install the brackets on 3639A models:

1. Remove the two small screws from the backside of the motor casing.
2. Align the **right** mounting bracket over the rotisserie rod receiver and two small screw holes. Then fasten the bracket to the motor using the existing screws. See Fig. 2-1.
3. Slide the rotisserie motor with the bracket into the slot on the right side of your grill, making sure the switch and cord are facing away from the grill.
4. Slide the **left** mounting bracket into the slot on the left side of the grill with the offset facing away from the grill.
5. Proceed to the ROTISSERIE INSTRUCTIONS section for rotisserie setup and use.

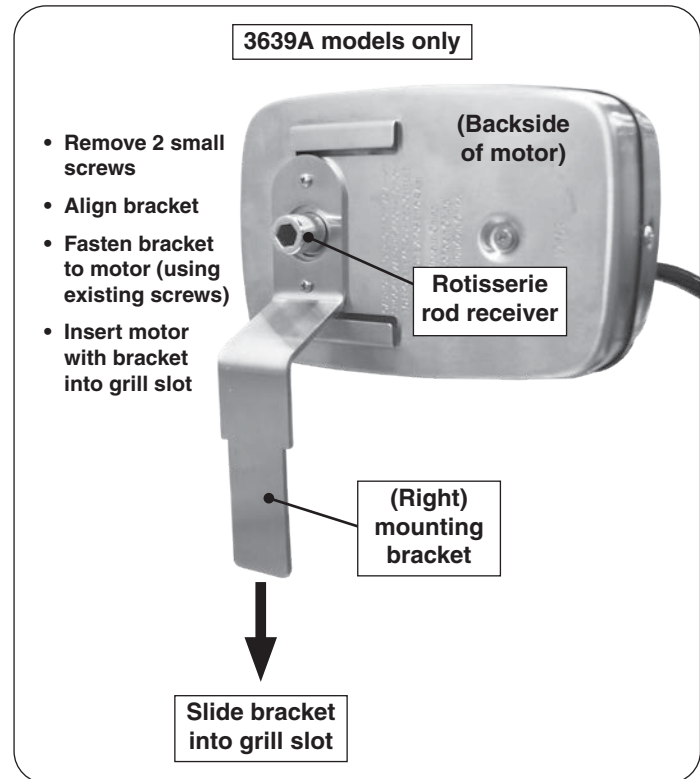

Fig. 2-1 Install bracket to rotisserie motor (3639A models only)

ROTISSERIE INSTRUCTIONS

CAUTION: WHEN USING THE BACKBURNER; KEEP THE OVEN LID CLOSED TO PREVENT HEAT LOSS, PROVIDE PROPER CONVECTION, AND PROVIDE PROPER VENTING. THIS WILL ENSURE EVEN COOKING TEMPERATURES.

DO NOT KEEP YOUR OVEN LID OPEN DURING ROTISSING, AS THIS MAY CAUSE PERSONAL INJURY, OR IN SOME CASES, IN WINDY CONDITIONS, DAMAGE TO THE GRILL.

DO NOT USE THE ROTISSERIE MOTOR IN THE RAIN. DO NOT LEAVE THE MOTOR ON THE GRILL WHEN NOT IN USE.

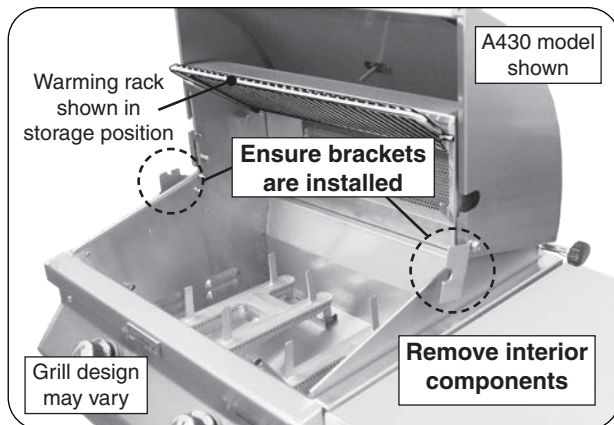

Fig. 3-1 Prepare grill for rotissing

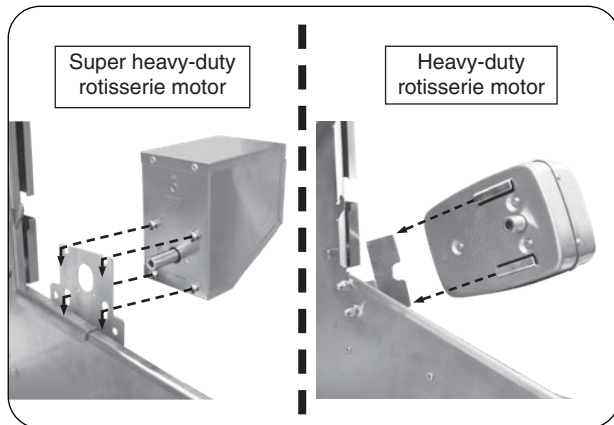

Fig. 3-2 Install rotisserie motor

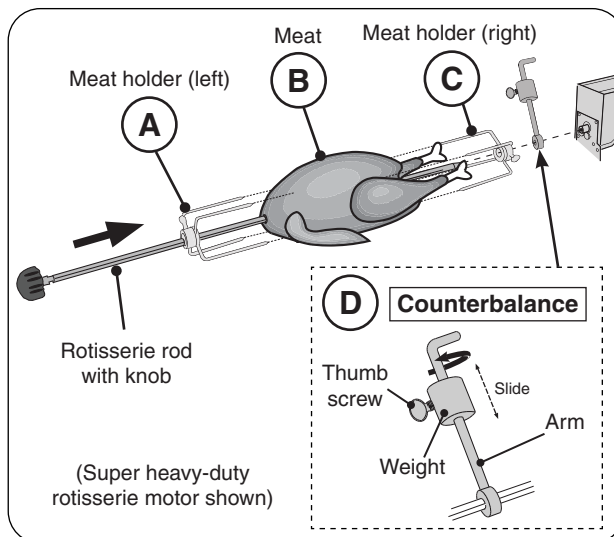

Fig. 3-3 Assemble rotisserie rod for cooking

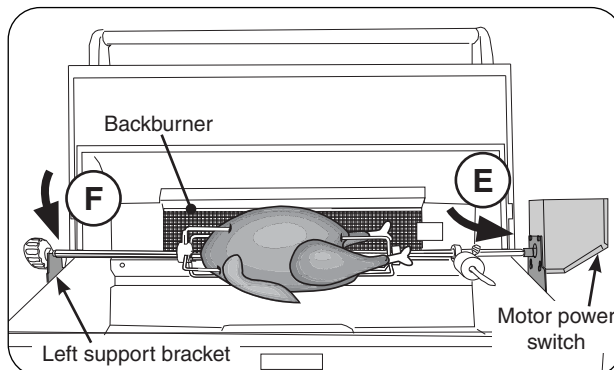

Fig. 3-4 Attach Rotisserie rod to motor

1. Ensure the rotisserie mounting brackets are properly installed on your grill (see Fig. 3-1).

Note: If your grill is not equipped with the brackets - and they were not included with your specific rotisserie kit - contact your dealer to order.

2. Set the warming rack to storage position, remove the backburner cover and cooking grids (see Fig. 3-1).

Note: Remove the flavor grids only if large meats require the clearance. The warming rack may also be removed if needed.

3. Slide the rotisserie motor fully onto the motor bracket located on the right side of the grill (see Fig. 3-2) and connect it to a power source (do not turn on).

4. Remove the rotisserie rod from the grill rear bracket and attach knob (if equipped). Clean the rod if needed.

5. Slide the left meat holder onto the rod and tighten (see Fig. 3-3, A).

6. Then slide meat onto the rod, followed by the right meat holder (see Fig. 3-3, B and C).

7. Slide the meat into the left holder, then the right holder into meat. Tighten the right meat holder. Be sure the meat is centered and balanced as well as possible, and the holders have a good grip on the meat.

8. Hold both ends of the rod so it settles freely (do not grip tightly). Allow the rod to rotate until the heavy side of the meat rests downward.

9. The counterbalance may then be attached to even weight distribution. Slide the counterbalance onto the rod next to the right meat holder (see Fig. 3-3, D). Loosen the arm and point it upward opposite the heavy side of the meat. Tighten the arm.

10. Slide the counterbalance weight up or down the arm until the rod rotates most evenly then tighten thumb screw (see Fig. 3-3, D).

11. Insert the pointed-end of the rod into the motor drive socket (see Fig. 3-4, E). Then rest rod groove (next to the knob) into the left support bracket (see Fig. 3-4, F).

12. To keep meat drippings off the burners and to simplify cleanup, place Fire Magic drip tray liners under the meat, if desired.

13. Press the motor power switch to start.

14. Light the backburner per the lighting instructions in this manual (or on drip tray handle) and close the oven lid.

Important: Turn the backburner to low or off when stopping the rotisserie to prevent overcooking.

Turkey Holder

Model # 3615 (Heavy-duty)
Model # 3615-E (Super Heavy-duty)

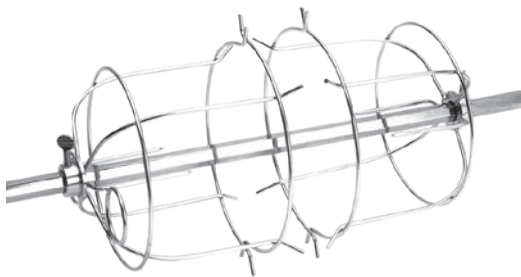

Chicken Holder

Model # 3617 (Heavy-duty)
Model # 3617-E (Super Heavy-duty)

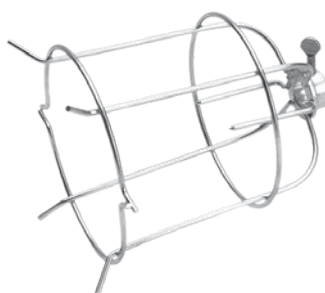

Flat Rotisserie Basket

Model # 3618

